

Ⓓ Aufbauanleitung

Ⓕ Notice de montage

Ⓖ Montagehandleiding

Ⓒ Montážní návod

Ⓗ Szerelési útmutató

Ⓓ Montaj talimatları

Ⓖ Assembly instruction

Ⓙ Istruzioni di montaggio

Ⓟ Instrukcja montażu

Ⓚ Navod na montaž

Ⓡ Instrucțiuni de montaj

Ⓡ Инструкция по монтажу

# 36-1026-45-000

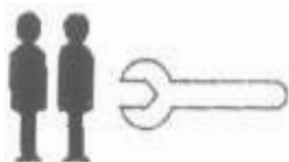
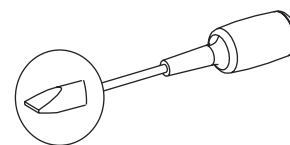
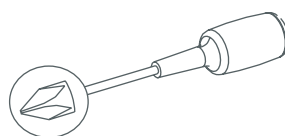
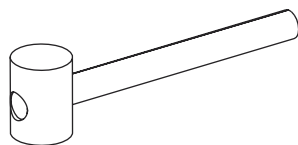
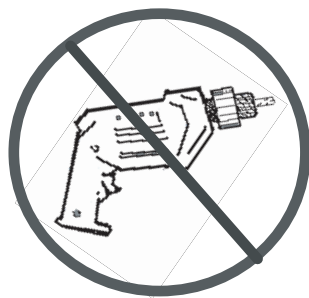
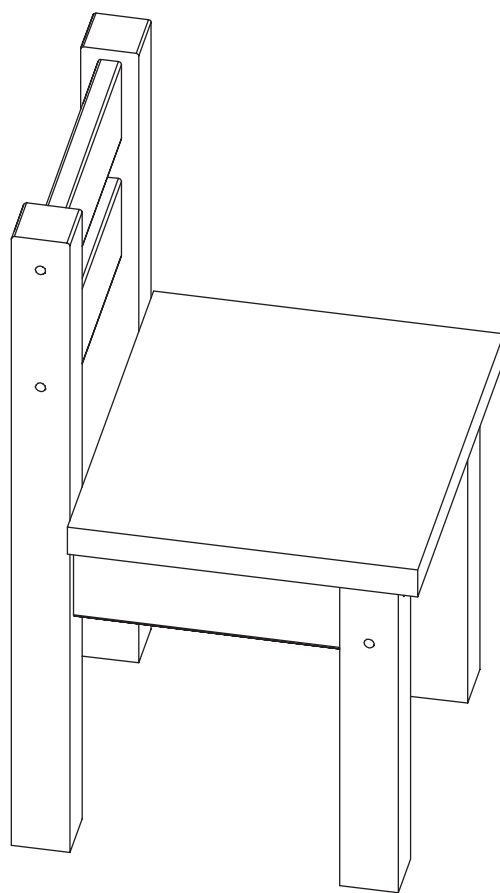

# Service • Assistenza • Dienstverlening • Serwis Servis • Szerviz • Сервисная служба

Name • Nom • Nome • Naam • Nazwa • Jméno • Názov  
Név • Denumire • Isim • Название

Nr. • No. • N° • Č • Sz • Номер

Typ • Type • Tip • Tipus • Druh • Тиро • Тип

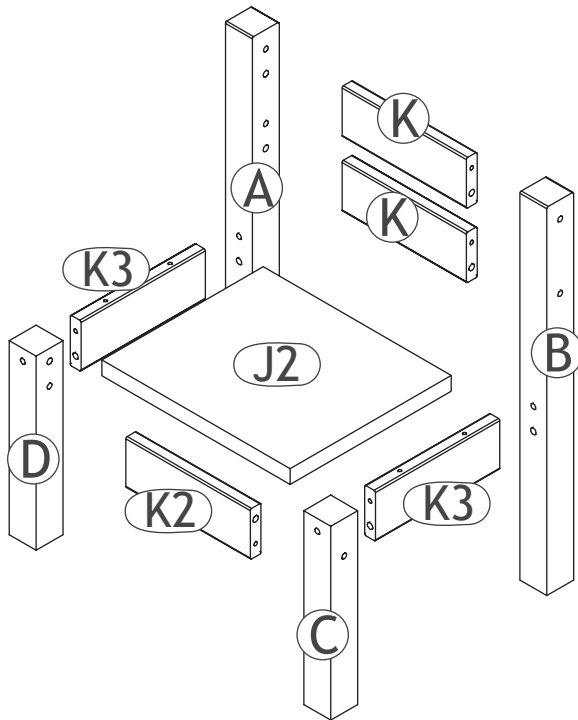
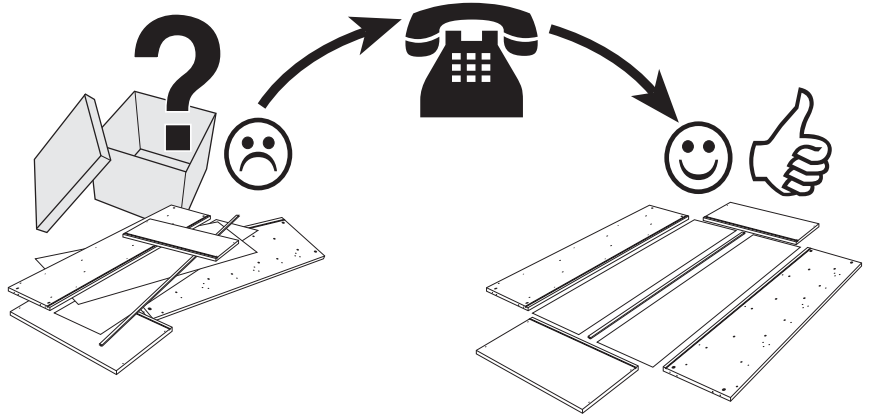
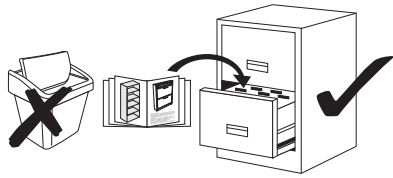

A	112122-45	x1
B	112121-45	x1
C	112211-45	x1
D	112212-45	x1
K	112224-45	x2
K2	112220-45	x1
K3	112223-45	x2
J2	112610-45	x1

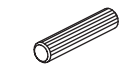
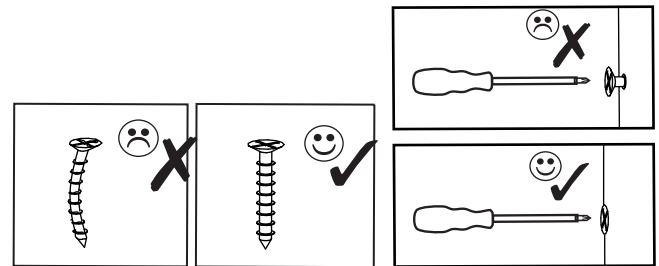

① (8x40)

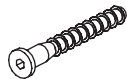

② (7x70)

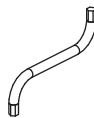

③ (d=4)



④ (4,5x80)

		mm	
①	1-000013-00	8x40	x10
②	1-000167-07	7x70	x10
③	1-000015-07	Z4	x1
④	1-000168-07	4.5x80	x4

1-000001=

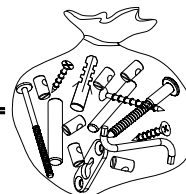

1.

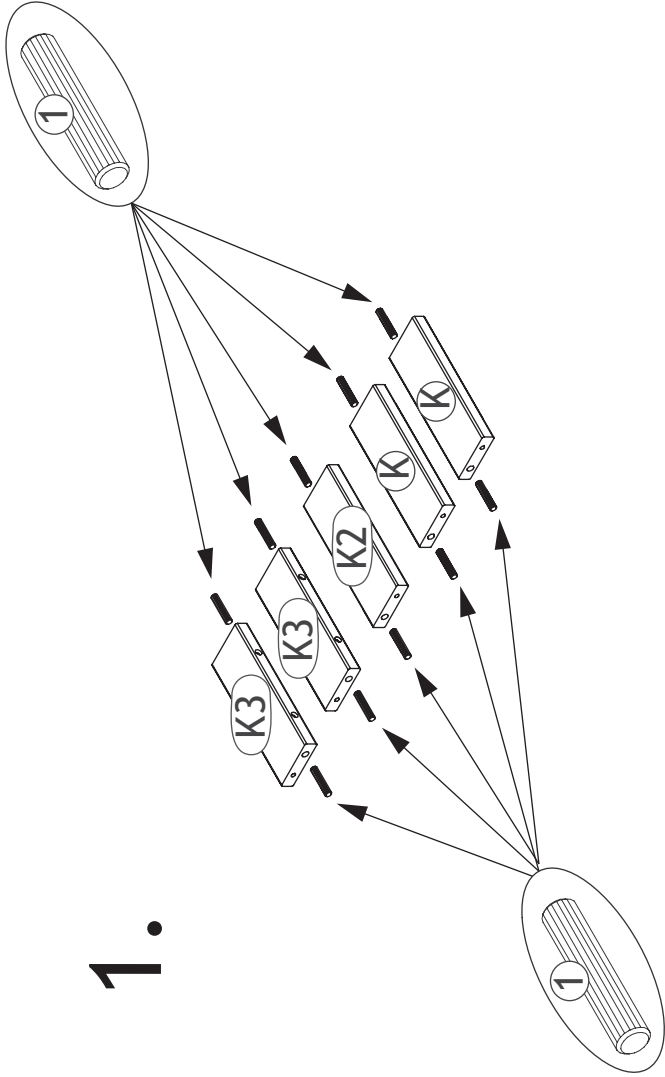

2.

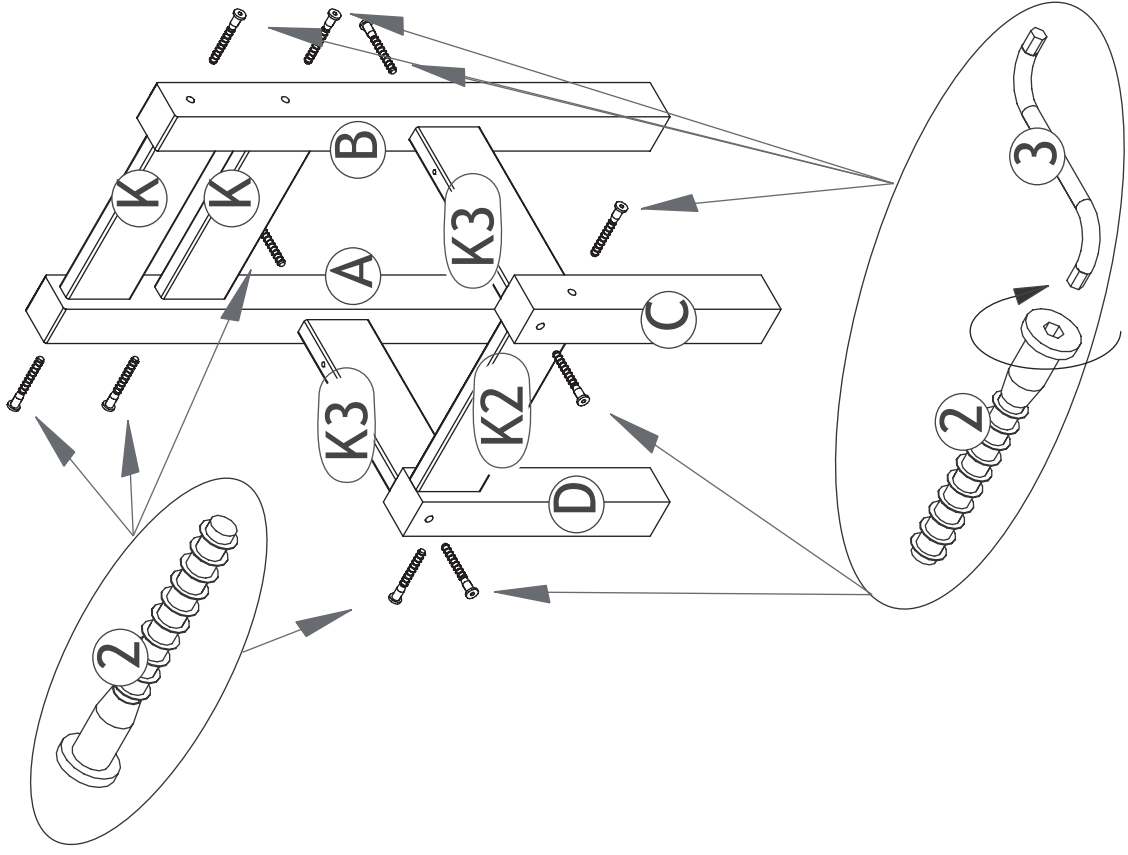

3.

