

Ⓓ Aufbauanleitung

Ⓕ Notice de montage

Ⓖ Montagehandleiding

Ⓒ Montážní návod

Ⓗ Szerelési útmutató

Ⓓ Montaj talimatları

Ⓖ Assembly instruction

Ⓙ Istruzioni di montaggio

Ⓟ Instrukcja montażu

Ⓙ Navod na montaž

Ⓡ Instrucțiuni de montaj

Ⓡ Инструкция по монтажу

# 37-0036-32-09A

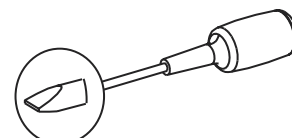
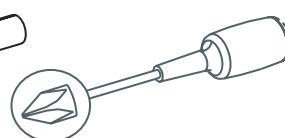
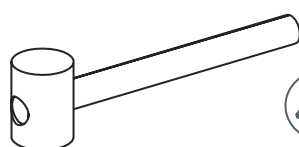
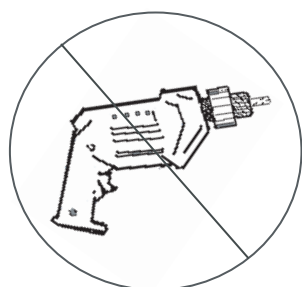
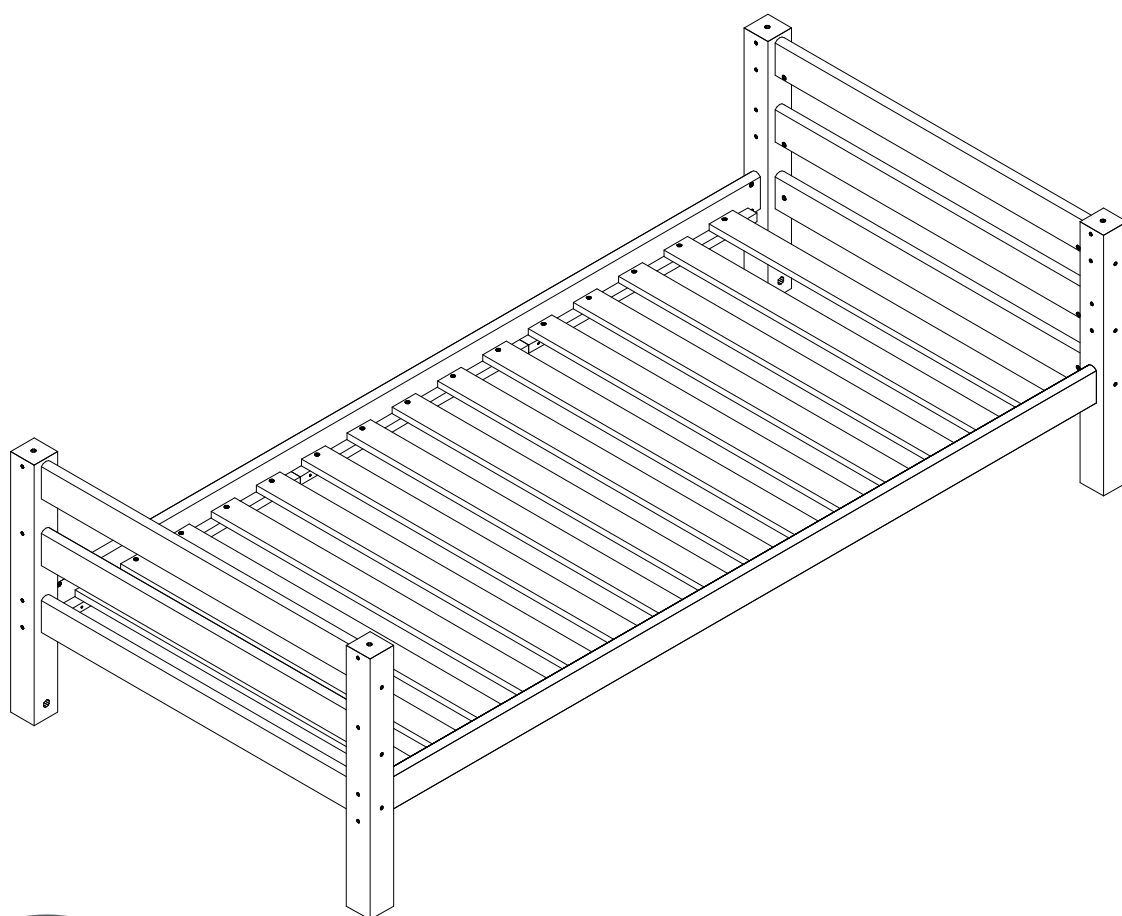

# Service • Assistenza • Dienstverlening • Serwis Servis • Szerviz • Сервисная служба

Name • Nom • Nome • Naam • Nazwa • Jméno • Názov  
Név • Denumire • Isim • Название

Nr. Nr. • No. • N° • Č • Sz • Номер

Typ • Тип • Type • Tip • Tipus • Druh • Тиро • Тип

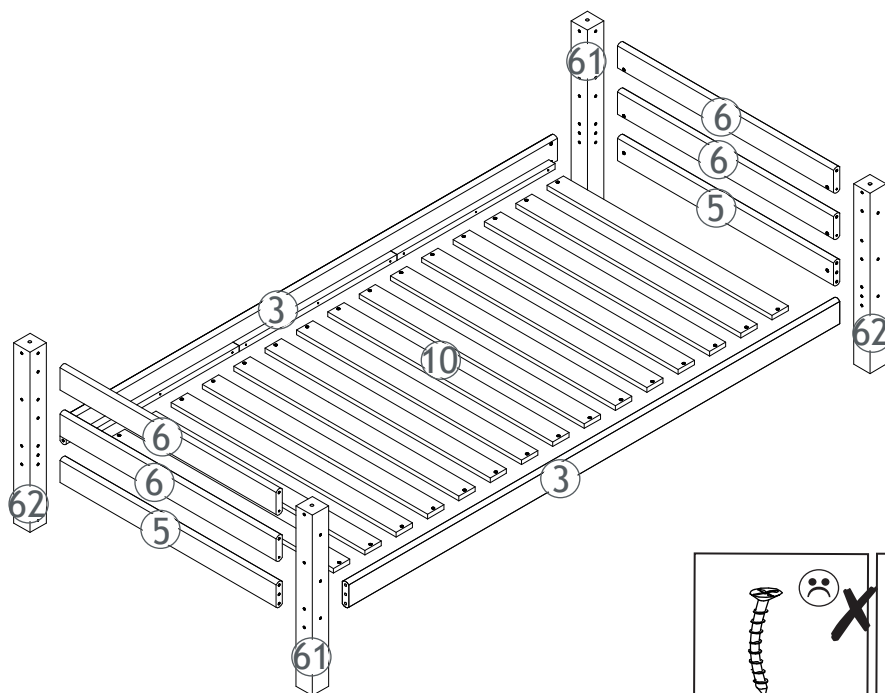
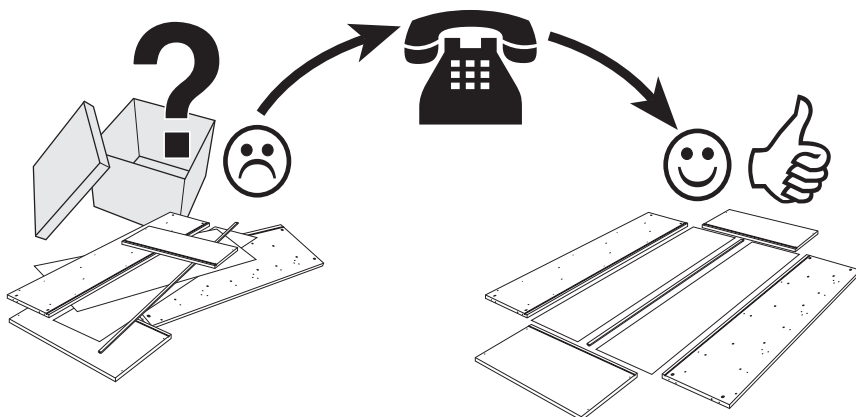
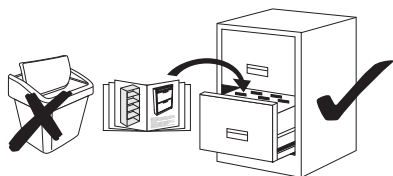

3	013003-32	x2
5	013005-32	x2
6	013006-32	x4
10	108820-00	x16
61	013061-32	x2
62	013062-32	x2

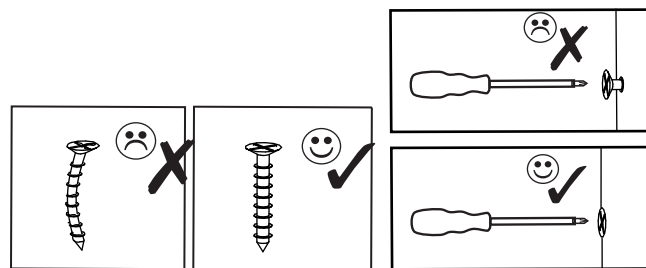

0  
10  
20  
30  
40  
50  
60  
70  
80  
90  
100  
110  
120  
130  
140  
150  
160  
170  
18

## Fitting specification

A.i. Nr.	Article Nr.	Dimentions	pcs
a	1-000011-07	10x18	x20
b	1-000010-07	M6x100	x20
c	1-000013-00	8x40	x20
d	1-000012-07	3x30	x32
e	1-000014-57	6x8	x24
f	1-000015-07	Z4	x1
g	1-000016-57	16x10	x4
k	1-000170-00	10x15	x4

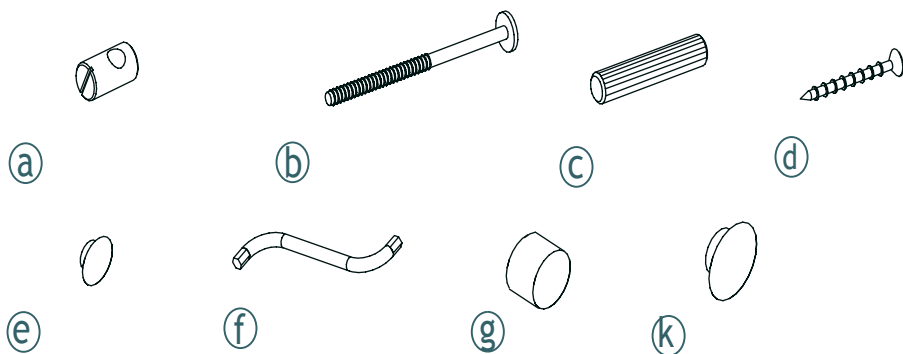

1-000001=

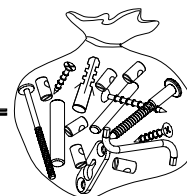

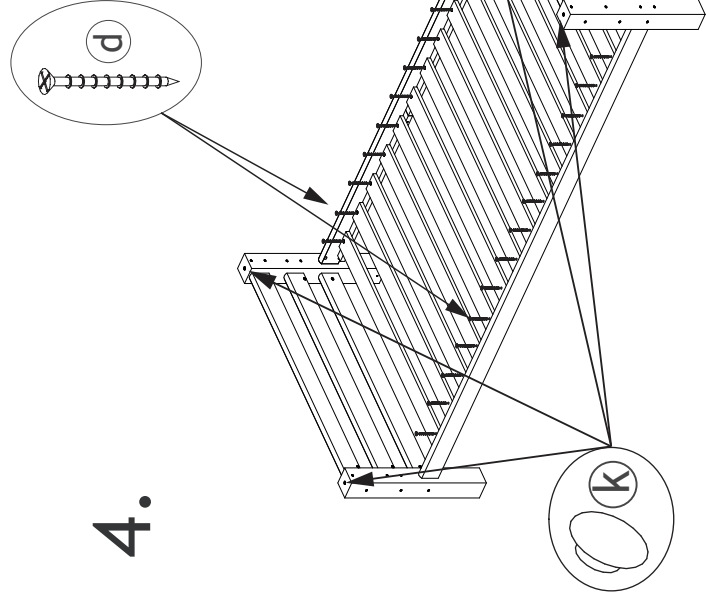
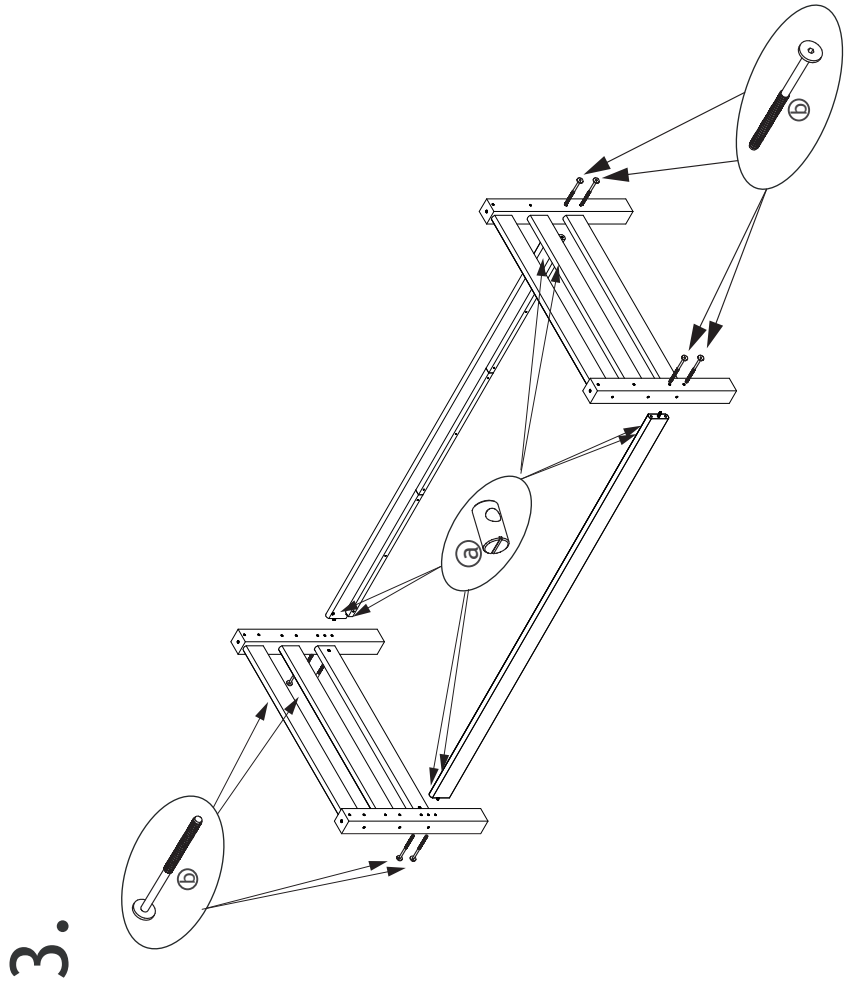
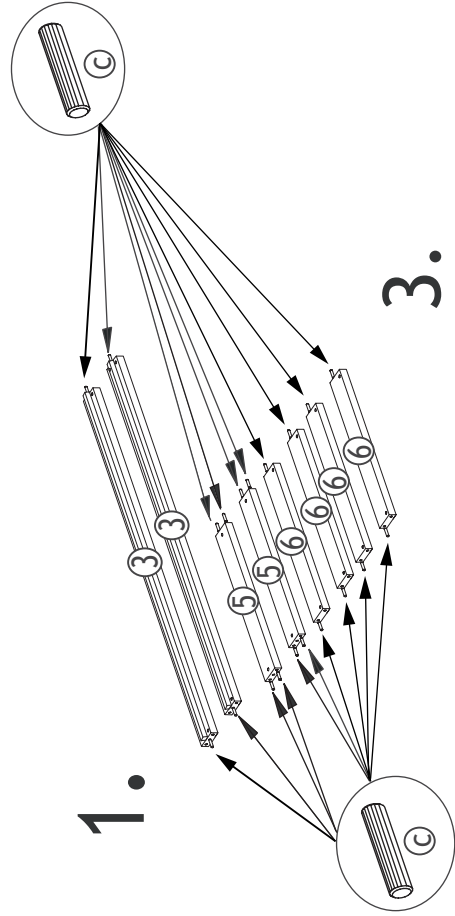
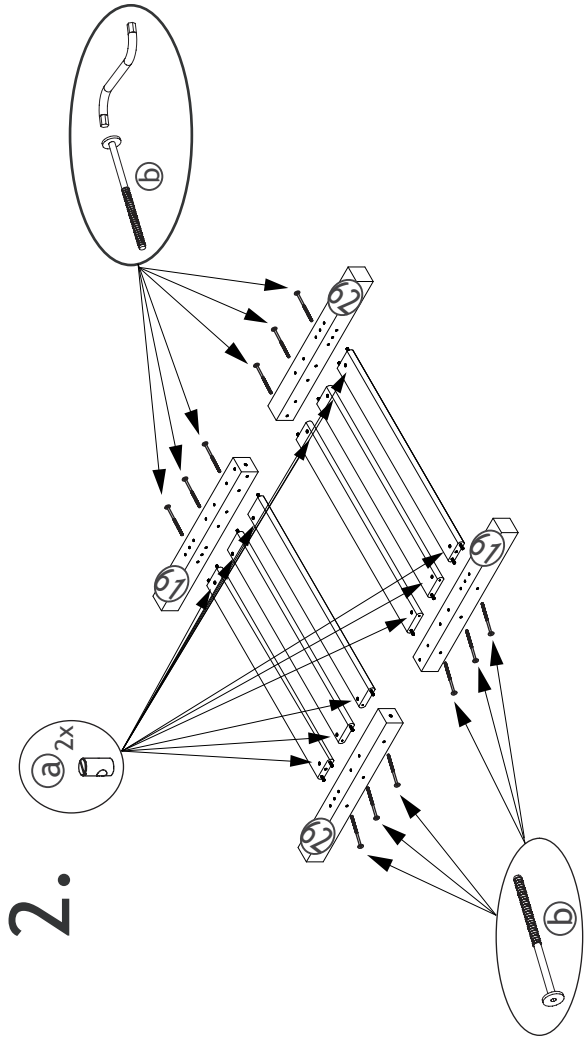

Close free holes with caps  
 Luk alle huller med propper  
 Schliessen Sie die offenen Löcher mit den Deckkappen  
 Fermez les trous découverts avec les chapes

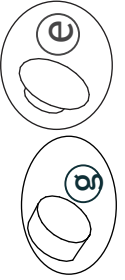

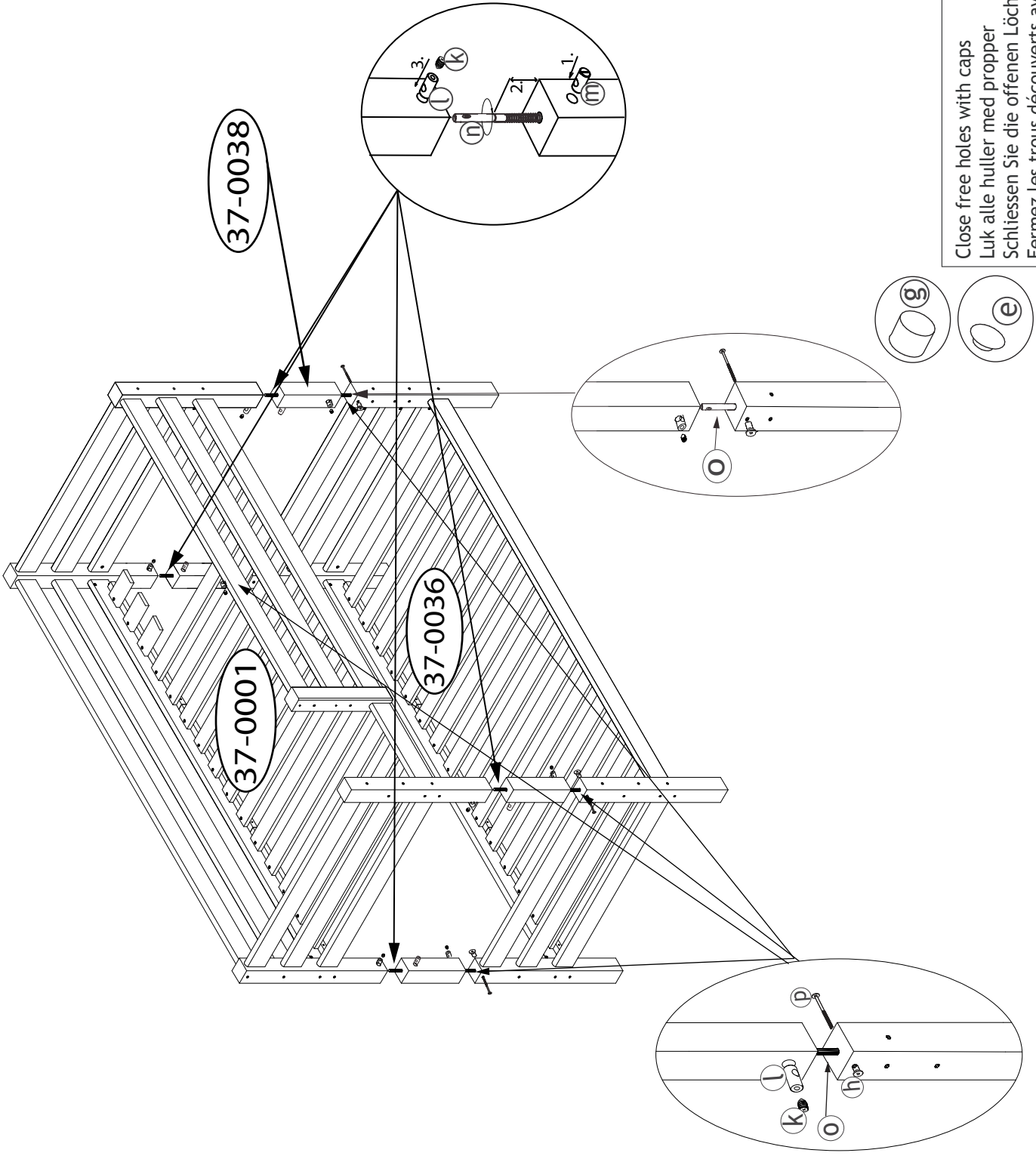

Close free holes with caps  
 Luk alle huller med propper  
 Schliessen Sie die offenen Löcher mit den Deckkappen  
 Fermez les trous découverts avec les chapes